

Heating circuit module HK12

Heating circuit module (HK) 12 for the module controller MR06 / 07/08/12
in use with the MR12 plug-in modules

Order number:	300.xxxxx
Order code:	Heizkreismodul-HK12 xxx

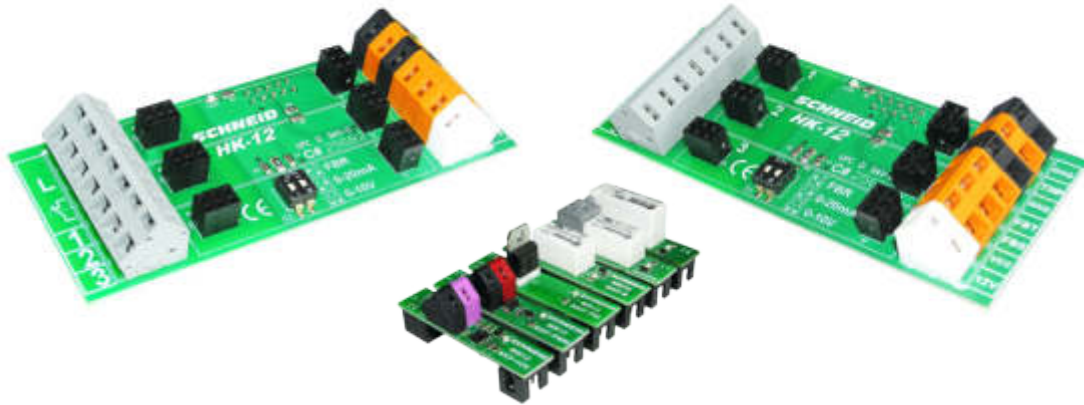

Overview:

The heating circuit module is used to connect to a SCHNEID basic module controller. With this module a complete mixer heating circuit including remote control connection possibility can be realized.

The following inputs and outputs are available:

- Three-point output heating circuit mixer
- Two-point output heating circuit pump
- Flow temperature sensor
- Remote control with built-in room sensor
- LED display for pump and mixer status

Innovations to the heating circuit module HK6:

The outputs on the HK12 board are implemented on plug-in modules and are available in the following variants:

Relais module standard

R16 Relais-module 16A / 250V

TRIAC module for controlling drives with a very high switching frequency (primary valves).

PWM module for controlling pumps with a PWM signal. In this case, the 230V terminal on the AKP is permanently connected to 230V. The PWM signal is connected to the plug-in module.

0-10V module for controlling pumps with 0-10V signal. In this case, the 230V terminal on the AKP is permanently connected to 230V. The 0-10V signal is connected to the plug-in module.

RPF module for controlling pumps with start-stop input. In this case, the 230V terminal on the AKP is permanently connected to 230V. The potential-free relay contact is connected to the plug-in module.

Heating circuit module HK12

Equipment variants:

Heating circuit module-HK12 without plug-in modules

Order number: 300.15999

Order code: Heizkreismodul-HK12 ohne Steckmodule
(with 10pol ribbon cable, 800mm standard)

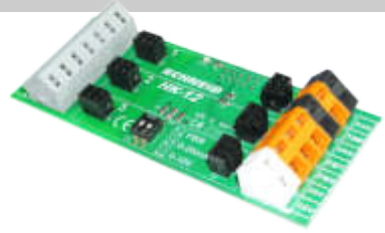

Heating circuit module-HK12 with 3 plug-in modules relay STD

Order number: 300.16129

Order code: Heizkreismodul-HK12 mit 3 Steckmodule Relais STD
(with 10pol ribbon cable, 800mm standard)



Relay plug-in module standard

Order number: 190.15206

Order code: MR12 Steckmodul Relais Standard für MR12-AKP/HK12



Relay plug-in module R16

Order number: 190.16614

Order code: MR12 Steckmodul Relais R16 für MR12-AKP & HK12



PWM plug-in module

Order number: 190.15209

Order code: MR12 Steckmodul PWM für MR12-AKP & HK12



TRIAC plug-in module

Order number: 190.15210

Order code: MR12 Steckmodul TRIAC für MR12-AKP & HK12



0-10V plug-in module

Order number: 190.15300

Order code: MR12 Steckmodul Analogsignal für MR12-AKP & HK12



Relay plug-in module RPF

Order number: 190.15404

Order code: MR12 Steckmodul Relais RPF für MR12-AKP & HK12



Heating circuit module HK12

Connection diagram:

Outputs 230VAC

- 1P1 Pump of Heating Circuit 1 1
- 1M1 Circuit 1 of Mixed Valve OPEN 2
- 1M1 Circuit 1 of Mixed Valve CLOSED 3

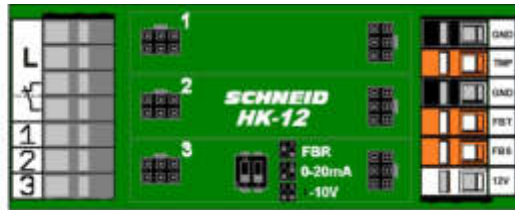

Heating Module Circuit 1

- GND Signalground
- TMP 1T1 Flow Temperature Circuit 1
- GND Remote Control Circuit 1
- FBT Remote Control Room Temperature
- FBS Remote Control Signal
- VCC Remote Control Supply

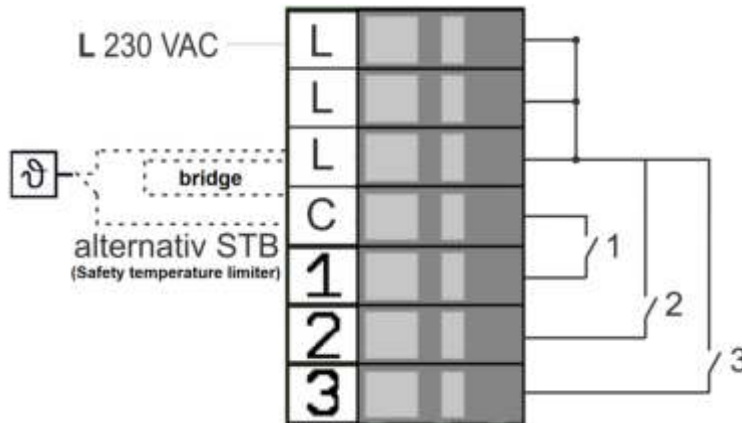

Connections 230V:

- L connection 230VAC
- L additional connection 230VAC (continuation to further module)
- 1 output heating circuit pump
- 2 output heating circuit mixer OPEN
- 3 heating circuit mixer CLOSE output
- N neutral conductor
- PE

Signal connections:

- GND Signalground
- TMP Heating circuit flow temperature sensor

- GND Signalground
- FBT Room temperature sensor
- FBS Remote control signal line
- VCC Remote control supply line

Heating circuit module HK12

Connection diagram:

Outputs 230VAC

- 1P1 Pump of Heating Circuit 1 1
- 1M1 Circuit 1 of Mixed Valve OPEN 2
- 1M1 Circuit 1 of Mixed Valve CLOSED 3

Outputs 230VAC

- 2P1 Pump of Heating Circuit 2 1
- 2M1 Circuit 2 of Mixed Valve OPEN 2
- 2M1 Circuit 2 of Mixed Valve CLOSED 3

Outputs 230VAC

- 3P1 Pump of Heating Circuit 3 1
- 3M1 Circuit 3 of Mixed Valve OPEN 2
- 3M1 Circuit 3 of Mixed Valve CLOSED 3

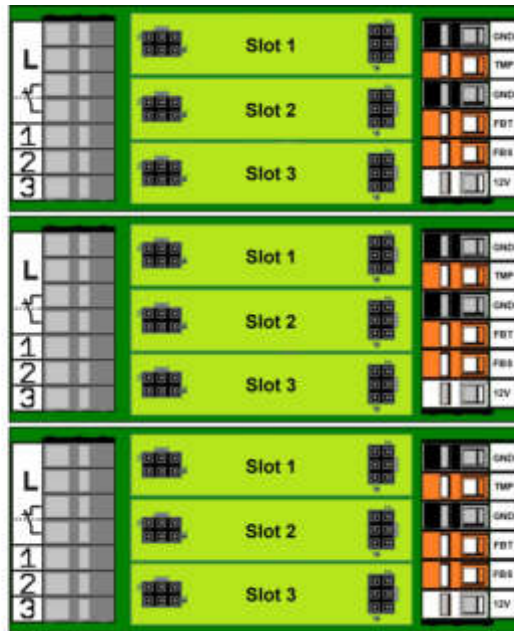

Heating Module Circuit 1

- GND
- TMP 1T1 Flow Temperature Circuit 1
- GND Remote Control Circuit 1
- FBT Remote Control Room Temperature
- FBS Remote Control Signal
- 12V VCC 12VDC

Heating Module Circuit 2

- GND
- TMP 2T1 Flow Temperature Circuit 2
- GND Remote Control Circuit 2
- FBT Remote Control Room Temperature
- FBS Remote Control Signal
- 12V VCC 12VDC

Heating Module Circuit 3

- GND
- TMP 3T1 Flow Temperature Circuit 3
- GND Remote Control Circuit 3
- FBT Remote Control Room Temperature
- FBS Remote Control Signal
- 12V VCC 12VDC

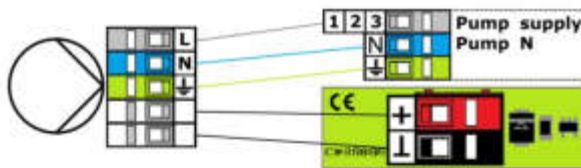

(Excerpt from the AKP-connection sheet)

Slot 1-3

(depending on the configuration required)

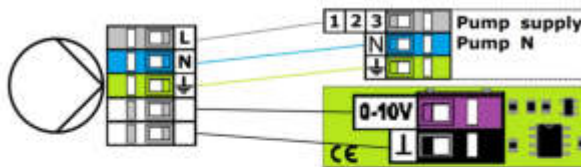

(Excerpt from the AKP-connection sheet)

Slot 1-3

(depending on the configuration required)

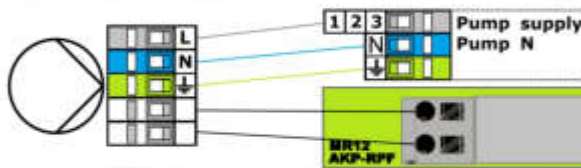

(Excerpt from the AKP-connection sheet)

Slot 1-3

(depending on the configuration required)

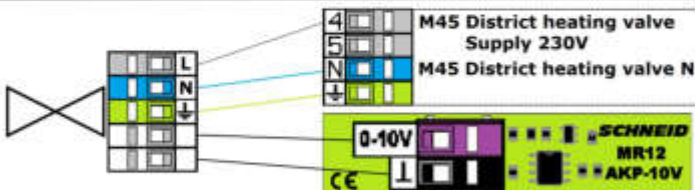

(Excerpt from the AKP-connection sheet)

Slot 4

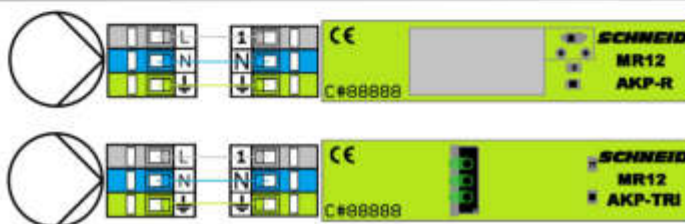

Heating circuit module HK12

Scope of delivery:

SCHNEID heating circuit module-HK12 xxx, with ribbon cable (800mm).

Technical specifications:

Intrastat Number	8537.10.91.90
Country of origin	EU/AT
Height, width, depth (in mm)	40x100x34
Weight in (kg)	0,077 (0,109 with 3 plug-in modules relais standard)
Degree of protection	IP-20
Ambient temperature	0°C....+40°C
Operating voltage	12VDC
Power consumption	< 1VA
Max. Nominal current per output	Fixed wiring terminals
Relay output life	Spring clamp
Connection type	Max. 2.5mm ²
Connection technology	DIN-RAIL TS35
Cable cross section	Continuous operation
Mounting type	2
Operating time	1kV
Degree of pollution	PT1000